

## 256K (32K x 8) Static RAM

### Features

- Fast access time: 12 ns, 15 ns, 20 ns, and 25 ns
- Wide voltage range: 5.0V ± 10% (4.5V to 5.5V)
- CMOS for optimum speed and power
- TTL-compatible inputs and outputs
- 2.0V data retention
- Low CMOS standby power
- Automated power down when deselected
- Available in Pb-free 28-pin TSOP I, 28-pin Molded SOJ and 28-pin DIP packages

### General Description <sup>[1]</sup>

The CY7C199CN is a high performance CMOS Asynchronous SRAM organized as 32K by 8 bits that supports an asynchronous memory interface. The device features an automatic power down feature that reduces power consumption when deselected.

See the “Truth Table” on page 3 in this data sheet for a complete description of read and write modes.

The CY7C199CN is available in Pb-free 28-pin TSOP I, 28-pin Molded SOJ and 28-pin DIP package(s).

### Logic Block Diagram

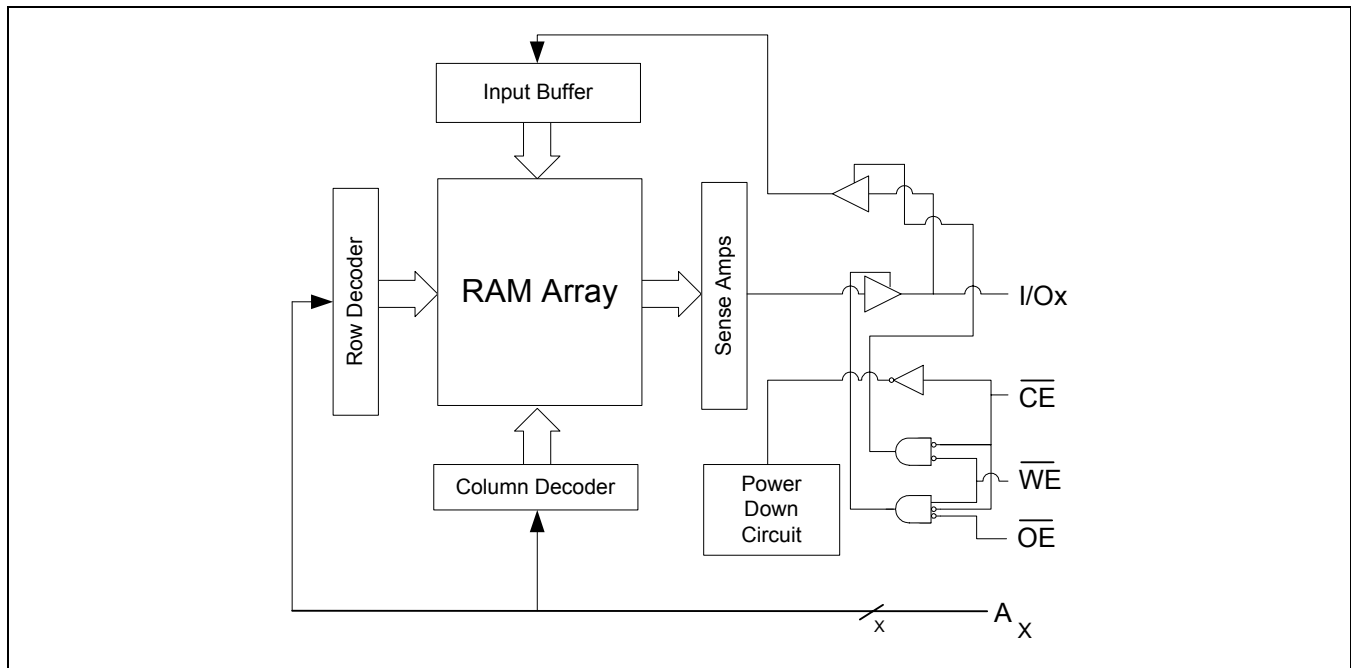

### Product Portfolio

	-12	-15	-20	-25	Unit
Maximum Access Time	12	15	20	25	ns
Maximum Operating Current	85	80	75	75	mA
Maximum CMOS Standby Current (low power)	500	500	500	500	μA

#### Note

1. For best practices recommendations, refer to the Cypress application note *System Design Guidelines* on [www.cypress.com](http://www.cypress.com).

Pin Layout and Specifications

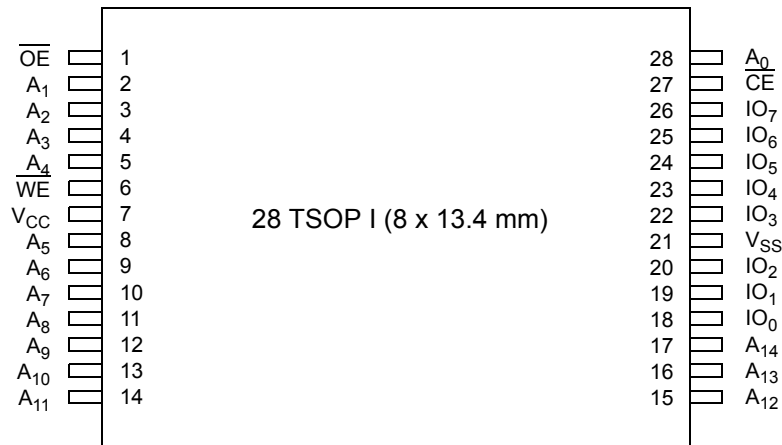
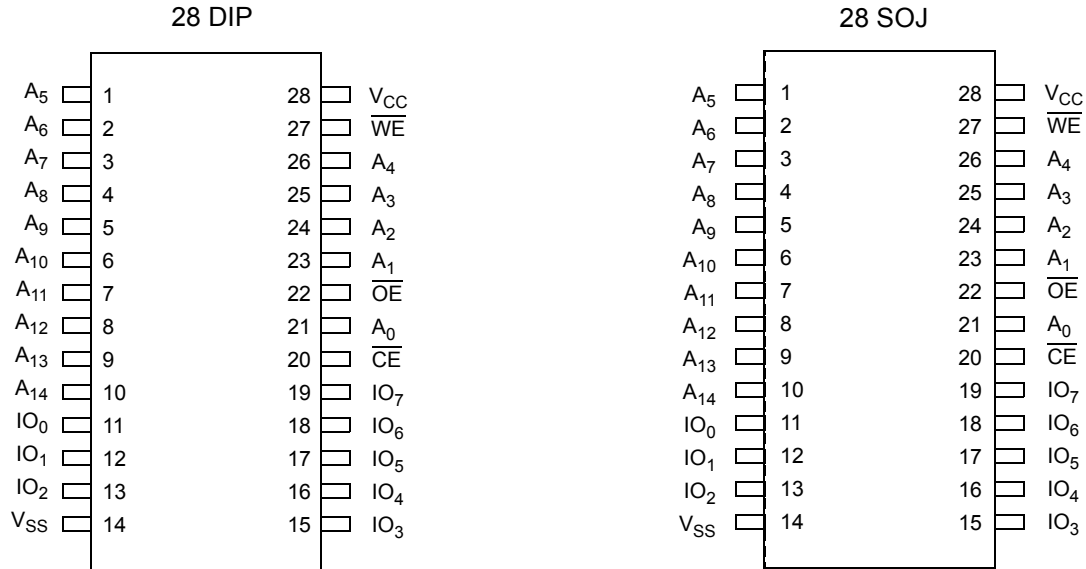

## Pin Description

Pin	Type	Description	DIP	SOJ	TSOP I
A <sub>X</sub>	Input	Address Inputs	1, 2, 3, 4, 5, 6, 7, 8, 9, 10, 21, 23, 24, 25, 26	1, 2, 3, 4, 5, 6, 7, 8, 9, 10, 21, 23, 24, 25, 26	2, 3, 4, 5, 8, 9, 10, 11, 12, 13, 14, 15, 16, 17, 28
$\overline{\text{CE}}$	Control	Chip Enable	20	20	27
IO <sub>X</sub>	Input or Output	Data Input Outputs	11, 12, 13, 15, 16, 17, 18, 19	11, 12, 13, 15, 16, 17, 18, 19	18, 19, 20, 22, 23, 24, 25, 26
$\overline{\text{OE}}$	Control	Output Enable	22	22	1
V <sub>CC</sub>	Supply	Power (5.0V)	28	28	7
V <sub>SS</sub>	Supply	Ground	14	14	21
$\overline{\text{WE}}$	Control	Write Enable	27	27	6

## Truth Table

$\overline{\text{CE}}$	$\overline{\text{OE}}$	$\overline{\text{WE}}$	IO <sub>X</sub>	Mode	Power
H	X	X	High-Z	Deselect/Power Down	Stand by (I <sub>SB</sub> )
L	L	H	Data Out	Read	Active (I <sub>CC</sub> )
L	X	L	Data In	Write	Active (I <sub>CC</sub> )
L	H	H	High-Z	Selected, Outputs Disabled	Active (I <sub>CC</sub> )

## Maximum Ratings

Exceeding maximum ratings may impair the useful life of the device. These user guidelines are not tested.

Parameter	Description	Value	Unit
T <sub>STG</sub>	Storage Temperature	-65 to +150	°C
T <sub>AMB</sub>	Ambient Temperature with Power Applied (that is, case temperature)	-55 to +125	°C
V <sub>CC</sub>	Core Supply Voltage Relative to V <sub>SS</sub>	-0.5 to +7.0	V
V <sub>IN</sub> , V <sub>OUT</sub>	DC Voltage Applied to Any Pin Relative to V <sub>SS</sub>	-0.5 to V <sub>CC</sub> + 0.5	V
I <sub>OUT</sub>	Output Short-Circuit Current	20	mA
V <sub>ESD</sub>	Static Discharge Voltage (in accordance with MIL-STD-883, Method 3015)	> 2001	V
I <sub>LU</sub>	Latch-up Current	> 200	mA

## Operating Range

Range	Ambient Temperature (T <sub>A</sub> )	Voltage Range (V <sub>CC</sub> )
Commercial	0°C to 70°C	5.0V ± 10%
Industrial	-40°C to 85°C	5.0V ± 10%
Automotive-A		

**DC Electrical Characteristics**

Over the Operating Range (–12, –15) [2]

Parameter	Description	Condition	Power	–12		–15		Unit
				Min	Max	Min	Max	
V <sub>IH</sub>	Input HIGH Voltage		–	2.2	V <sub>CC</sub> + 0.3	2.2	V <sub>CC</sub> + 0.3	V
V <sub>IL</sub>	Input LOW Voltage		–	–0.5	0.8	–0.5	0.8	V
V <sub>OH</sub>	Output HIGH Voltage	V <sub>CC</sub> = Min, I <sub>OH</sub> = –4.0 mA	–	2.4	–	2.4	–	V
V <sub>OL</sub>	Output LOW Voltage	V <sub>CC</sub> = Min, I <sub>OL</sub> = 8.0 mA	–	–	0.4	–	0.4	V
I <sub>CC</sub>	V <sub>CC</sub> Operating Supply Current	V <sub>CC</sub> = Max, I <sub>OUT</sub> = 0 mA, f = F <sub>max</sub> = 1/t <sub>RC</sub>	–	–	85	–	80	mA
I <sub>SB1</sub>	Automatic $\overline{CE}$ Power Down Current TTL Inputs	Max V <sub>CC</sub> , $\overline{CE} \geq V_{IH}$ , V <sub>IN</sub> ≥ V <sub>IH</sub> or V <sub>IN</sub> ≤ V <sub>IL</sub> , f = F <sub>max</sub>	–	–	30	–	30	mA
			L	–	10	–	10	mA
I <sub>SB2</sub>	Automatic $\overline{CE}$ Power Down Current CMOS Inputs	Max V <sub>CC</sub> , $\overline{CE} \geq V_{CC} - 0.3V$ , V <sub>IN</sub> ≥ V <sub>CC</sub> – 0.3V, or V <sub>IN</sub> ≤ 0.3V, f = 0	–	–	10	–	10	mA
			L	–	500	–	500	μA
I <sub>OZ</sub>	Output Leakage Current	GND ≤ V <sub>I</sub> ≤ V <sub>CC</sub> , Output Disabled	–	–5	+5	–5	+5	μA
I <sub>IX</sub>	Input Leakage Current	GND ≤ V <sub>I</sub> ≤ V <sub>CC</sub>	–	–5	+5	–5	+5	μA

**DC Electrical Characteristics**

Over the Operating Range (–20, –25) [2]

Parameter	Description	Condition	Power	–20		–25		Unit
				Min	Max	Min	Max	
V <sub>IH</sub>	Input HIGH Voltage		–	2.2	V <sub>CC</sub> + 0.3	2.2	V <sub>CC</sub> + 0.3	V
V <sub>IL</sub>	Input LOW Voltage		–	–0.5	0.8	–0.5	0.8	V
V <sub>OH</sub>	Output HIGH Voltage	V <sub>CC</sub> = Min, I <sub>OH</sub> = –4.0 mA	–	2.4	–	2.4	–	V
V <sub>OL</sub>	Output LOW Voltage	V <sub>CC</sub> = Min, I <sub>OL</sub> = 8.0 mA	–	–	0.4	–	0.4	V
I <sub>CC</sub>	V <sub>CC</sub> Operating Supply Current	V <sub>CC</sub> = Max, I <sub>OUT</sub> = 0 mA, f = F <sub>max</sub> = 1/t <sub>RC</sub>	–	–	75	–	75	mA
I <sub>SB1</sub>	Automatic $\overline{CE}$ Power Down Current TTL Inputs	Max V <sub>CC</sub> , $\overline{CE} \geq V_{IH}$ , V <sub>IN</sub> ≥ V <sub>IH</sub> or V <sub>IN</sub> ≤ V <sub>IL</sub> , f = F <sub>max</sub>	–	–	30	–	30	mA
			L	–	10	–	10	mA
I <sub>SB2</sub>	Automatic $\overline{CE}$ Power Down Current CMOS Inputs	Max V <sub>CC</sub> , $\overline{CE} \geq V_{CC} - 0.3V$ , V <sub>IN</sub> ≥ V <sub>CC</sub> – 0.3V, or V <sub>IN</sub> ≤ 0.3V, f = 0	–	–	10	–	10	mA
			L	–	500	–	500	μA
I <sub>OZ</sub>	Output Leakage Current	GND ≤ V <sub>i</sub> ≤ V <sub>CC</sub> , Output Disabled	–	–5	+5	–5	+5	μA
I <sub>IX</sub>	Input Leakage Current	GND ≤ V <sub>i</sub> ≤ V <sub>CC</sub>	–	–5	+5	–5	+5	μA

**Note**

 2. V<sub>IL</sub> (min) = –2.0V for pulse durations of less than 20 ns.

**Capacitance** <sup>[3]</sup>

Parameter	Description	Conditions	Max	Unit
$C_{IN}$	Input Capacitance	$T_A = 25^\circ\text{C}$ , $f = 1\text{ MHz}$ , $V_{CC} = 5.0\text{V}$	8	pF
$C_{OUT}$	Output Capacitance		8	

**Thermal Resistance** <sup>[3]</sup>

Parameter	Description	Conditions	TSOP I	SOJ	DIP	Unit
$\Theta_{JA}$	Thermal Resistance (junction to ambient)	Still air, soldered on a $3 \times 4.5$ square inch, two-layer printed circuit board	88.6	79	69.33	$^\circ\text{C/W}$
$\Theta_{JC}$	Thermal Resistance (junction to case)		21.94	41.42	31.62	

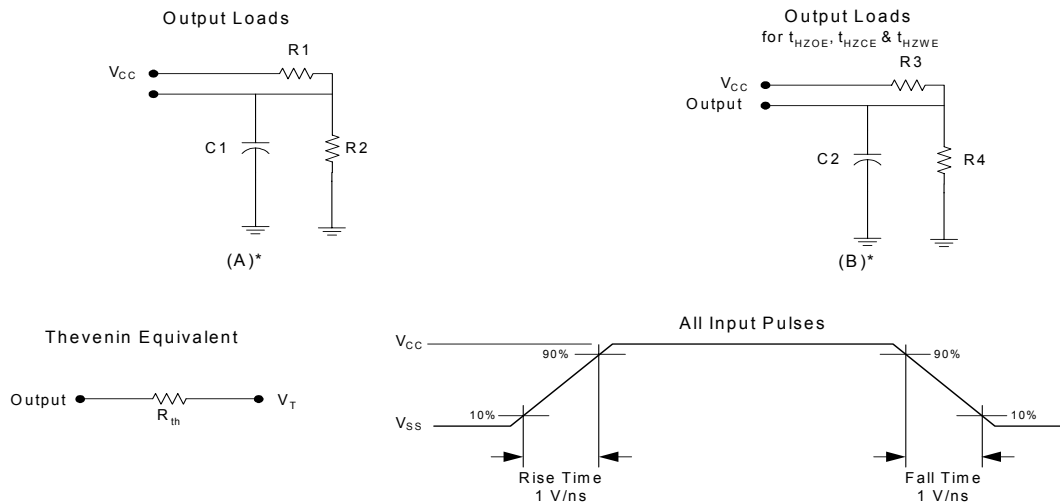
**AC Test Loads**

\* including scope and jig capacitance

**AC Test Conditions**

Parameter	Description	Nom	Unit
C1	Capacitor 1	30	pF
C2	Capacitor 2	5	
R1	Resistor 1	480	$\Omega$
R2	Resistor 2	255	
R3	Resistor 3	480	
R4	Resistor 4	255	
$R_{TH}$	Resistor Thevenin	167	
$V_{TH}$	Voltage Thevenin	1.73	V

**Note**

3. Tested initially and after any design or process change that may affect these parameters.

**AC Electrical Characteristics** <sup>[4]</sup>

Parameter	Description	-12		-15		-20		-25		Unit	
		Min	Max	Min	Max	Min	Max	Min	Max		
t <sub>RC</sub>	Read Cycle Time	12	–	15	–	20	–	25	–	ns	
t <sub>AA</sub>	Address to Data Valid	–	12	–	15	–	20	–	25	ns	
t <sub>OHA</sub>	Data Hold from Address Change	3	–	3	–	3	–	3	–	ns	
t <sub>ACE</sub>	$\overline{CE}$ to Data Valid	–	12	–	15	–	20	–	25	ns	
t <sub>DOE</sub>	$\overline{OE}$ to Data Valid	Ind'l/Com'l	–	5	–	7	–	9	–	9	ns
		Automotive-A	–	6	–	–	–	–	–	–	
t <sub>LZOE</sub>	$\overline{OE}$ to Low-Z <sup>[5]</sup>	0	–	0	–	0	–	0	–	ns	
t <sub>HZOE</sub>	$\overline{OE}$ to High-Z <sup>[5, 6]</sup>	–	5	–	7	–	9	–	9	ns	
t <sub>LZCE</sub>	$\overline{CE}$ to Low-Z <sup>[5]</sup>	3	–	3	–	3	–	3	–	ns	
t <sub>HZCE</sub>	$\overline{CE}$ to High-Z <sup>[5, 6]</sup>	–	5	–	7	–	9	–	9	ns	
t <sub>PU</sub>	$\overline{CE}$ to Power Up	0	–	0	–	0	–	0	–	ns	
t <sub>PD</sub>	$\overline{CE}$ to Power Down	–	12	–	15	–	20	–	20	ns	
t <sub>WC</sub>	Write Cycle Time <sup>[7]</sup>	12	–	15	–	20	–	25	–	ns	
t <sub>SCE</sub>	$\overline{CE}$ to Write End	9	–	10	–	15	–	15	–	ns	
t <sub>AW</sub>	Address Setup to Write End	9	–	10	–	15	–	15	–	ns	
t <sub>HA</sub>	Address Hold from Write End	0	–	0	–	0	–	0	–	ns	
t <sub>SA</sub>	Address Setup to Write Start	0	–	0	–	0	–	0	–	ns	
t <sub>PWE</sub>	$\overline{WE}$ Pulse Width	8	–	9	–	15	–	15	–	ns	
t <sub>SD</sub>	Data Setup to Write End	8	–	9	–	10	–	10	–	ns	
t <sub>HD</sub>	Data Hold from Write End	0	–	0	–	0	–	0	–	ns	
t <sub>HZWE</sub>	$\overline{WE}$ LOW to High-Z <sup>[5, 6]</sup>	–	7	–	7	–	10	–	10	ns	
t <sub>LZWE</sub>	$\overline{WE}$ HIGH to Low-Z <sup>[5]</sup>	3	–	3	–	3	–	3	–	ns	

**Data Retention Characteristics** <sup>[8]</sup>

Parameter	Description	Condition	Min	Max	Unit
V <sub>DR</sub>	V <sub>CC</sub> for Data Retention		2.0	–	V
I <sub>CCDR</sub>	Data Retention Current	V <sub>CC</sub> = V <sub>DR</sub> = 2.0V, $\overline{CE} \geq V_{CC} - 0.3V$ , V <sub>IN</sub> ≥ V <sub>CC</sub> – 0.3V or V <sub>IN</sub> ≤ 0.3V	–	150	μA
t <sub>CDR</sub>	Chip Deselect to Data Retention Time		0	–	ns
t <sub>R</sub>	Operation Recovery Time		200	–	μs

**Notes**

- Test Conditions are based on a transition time of 3 ns or less and timing reference levels of 1.5V, and input pulse levels of 0 to 3.0V.
- At any given temperature and voltage condition, t<sub>HZCE</sub> is less than t<sub>LZCE</sub>, t<sub>HZOE</sub> is less than t<sub>LZOE</sub>, and t<sub>HZWE</sub> is less than t<sub>LZWE</sub> for any given device.
- t<sub>HZOE</sub>, t<sub>HZCE</sub>, t<sub>HZWE</sub> are specified as in part (b) of the "" on page 1. Transitions are measured ± 200 mV from steady state voltage.
- The internal memory write time is defined by the overlap of  $\overline{CE}$  LOW and  $\overline{WE}$  LOW.  $\overline{CE}$  and  $\overline{WE}$  must be LOW to initiate a write, and the transition of any of these signals can terminate the write. The input data setup and hold timing must be referenced to the leading edge of the signal that terminates the write.
- L-version only.

## Timing Waveforms

### Data Retention Waveform

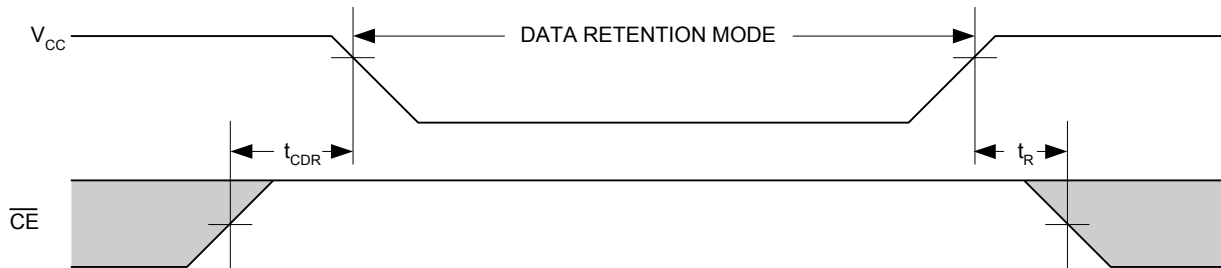

### Read Cycle 1 [9, 10]

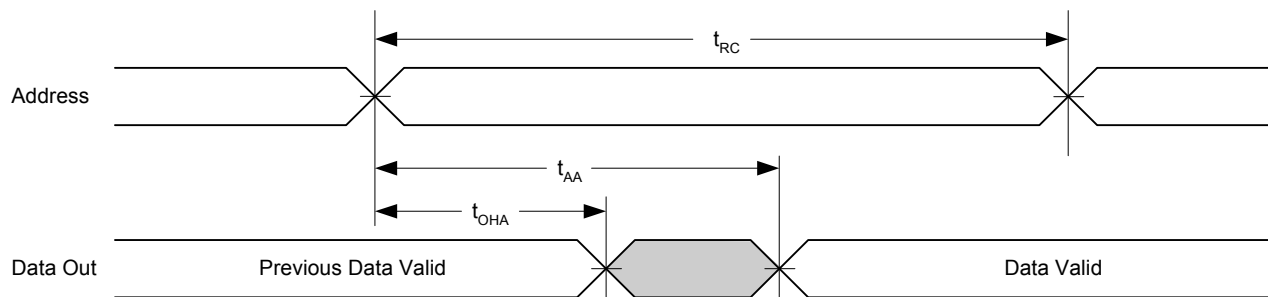

### Read Cycle 2 [11, 12]

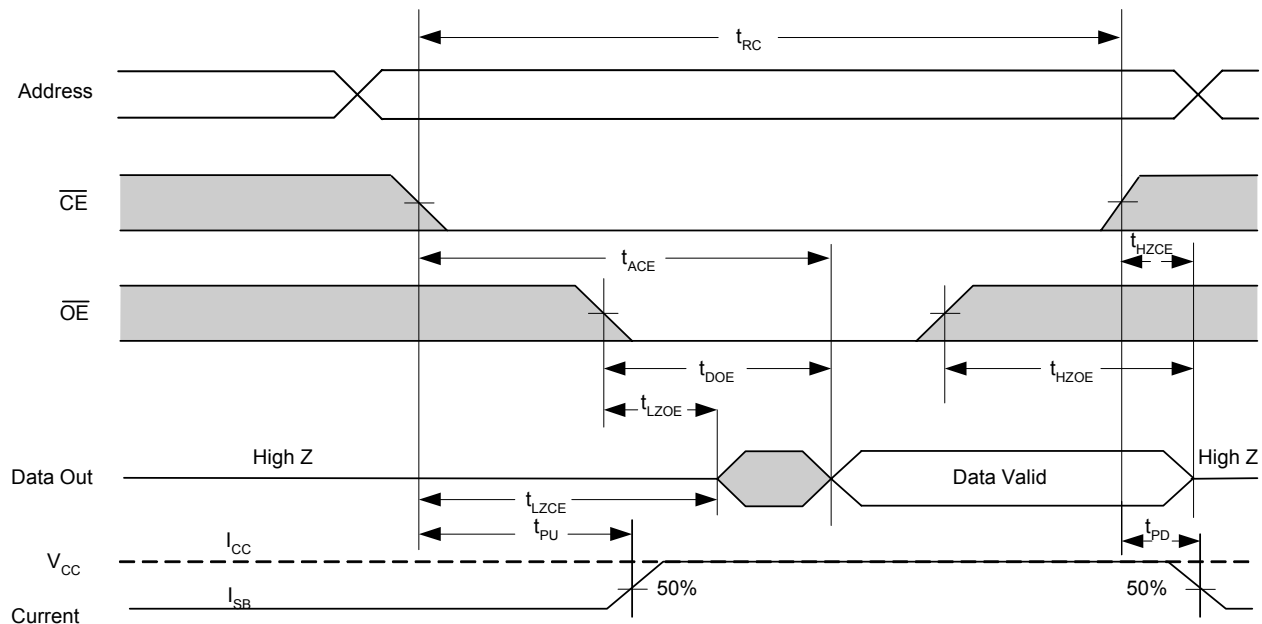

#### Notes

9. Device is continuously selected.  $\overline{OE} = V_{IL} = \overline{CE}$ .
10.  $\overline{WE}$  is HIGH for read cycle.
11. This cycle is  $\overline{OE}$  controlled and  $\overline{WE}$  is HIGH read cycle.
12. Address valid before or similar with  $\overline{CE}$  transition LOW.

**Timing Waveforms (continued)**

**Write Cycle 1 ( $\overline{WE}$  controlled) [13, 14, 15]**

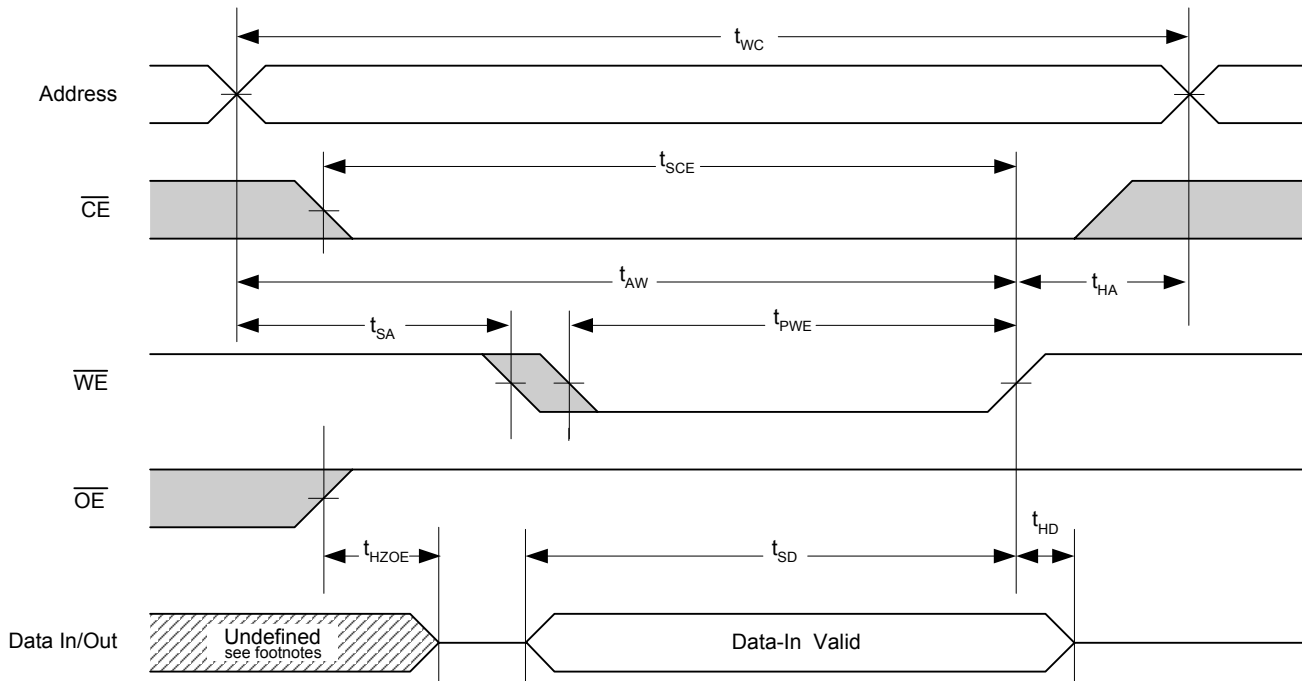

**Write Cycle 2 ( $\overline{CE}$  controlled) [14, 16, 17]**

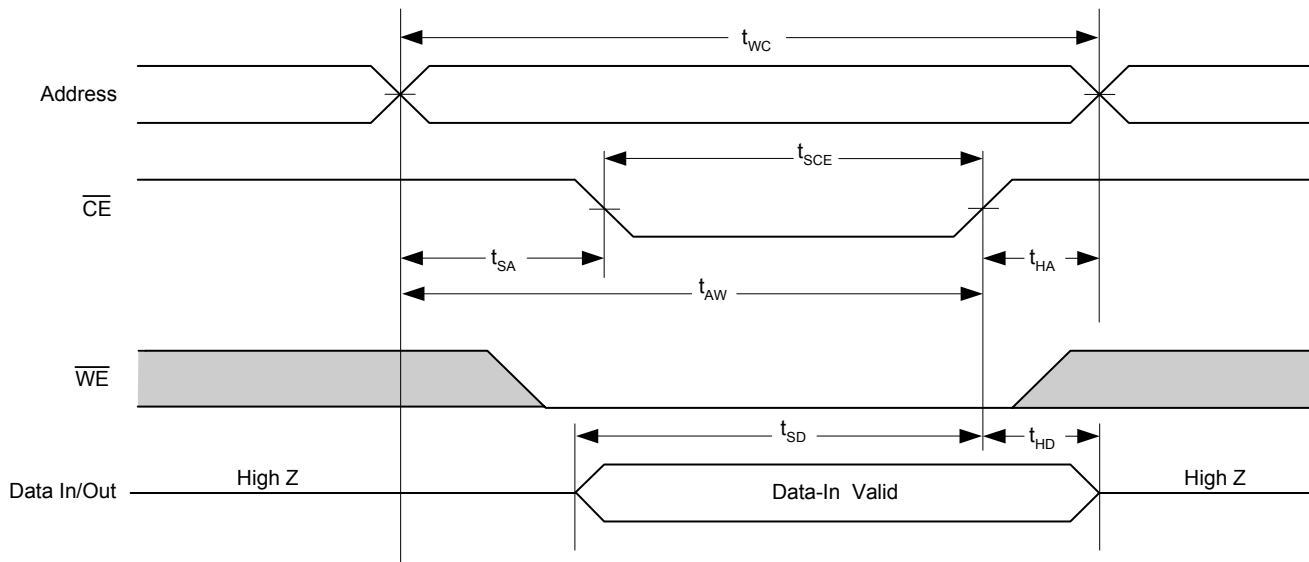

**Notes**

13. This cycle is  $\overline{WE}$  controlled,  $\overline{OE}$  is HIGH during write.
14. Data in and/or out is high impedance if  $\overline{OE} = V_{IH}$ .
15. During this period the IOs are in output state and input signals must not be applied.
16. This cycle is  $\overline{CE}$  controlled.
17. If  $\overline{CE}$  goes HIGH simultaneously with  $\overline{WE}$  going HIGH, the output remains in a high impedance state.



Timing Waveforms (continued)

Write Cycle 3 ( $\overline{WE}$  controlled,  $\overline{OE}$  low) [18]

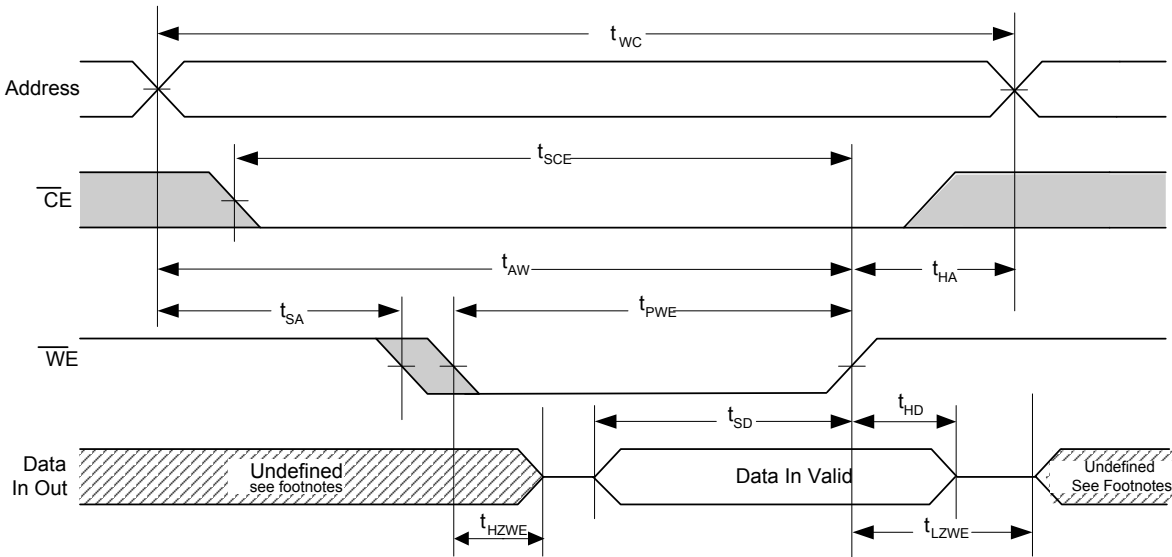

Note

18. The cycle is  $\overline{WE}$  controlled,  $\overline{OE}$  LOW. The minimum write cycle time is the sum of  $t_{HZWE}$  and  $t_{SD}$ .

**Ordering Information**

Contact local sales representative regarding availability of these parts.

Speed (ns)	Ordering Code	Package Diagram	Package Type	Power Option	Operating Range
12	CY7C199CN-12VC	51-85031	28-Lead (300-Mil) Molded SOJ	Standard	Commercial
	CY7C199CN-12ZC	51-85071	28 TSOP I (8 x 13.4 mm)	Standard	Commercial
	CY7C199CN-12ZXC	51-85071	28 TSOP I (8 x 13.4 mm), Pb-free	Standard	Commercial
	CY7C199CN-12VI	51-85031	28-Lead (300-Mil) Molded SOJ	Standard	Industrial
	CY7C199CN-12VXI	51-85031	28-Lead (300-Mil) Molded SOJ, Pb-free	Standard	Industrial
	CY7C199CN-12VXA	51-85031	28-Lead (300-Mil) Molded SOJ, Pb-free	Standard	Automotive-A
15	CY7C199CN-15PC	51-85014	28 DIP (6.9 x 35.6 x 3.5 mm)	Standard	Commercial
	CY7C199CN-15PXC	51-85014	28 DIP (6.9 x 35.6 x 3.5 mm), Pb-free	Standard	Commercial
	CY7C199CN-15VC	51-85031	28-Lead (300-Mil) Molded SOJ	Standard	Commercial
	CY7C199CN-15VXC	51-85031	28-Lead (300-Mil) Molded SOJ, Pb-free	Standard	Commercial
	CY7C199CN-15ZC	51-85071	28 TSOP I (8 x 13.4 mm), Pb-free	Standard	Commercial
	CY7C199CN-15ZXC	51-85071	28 TSOP I (8 x 13.4 mm), Pb-free	Standard	Commercial
	CY7C199CN-15VI	51-85031	28-Lead (300-Mil) Molded SOJ	Standard	Industrial
	CY7C199CNL-15VC	51-85031	28-Lead (300-Mil) Molded SOJ	Low Power	Commercial
	CY7C199CNL-15VXC	51-85031	28-Lead (300-Mil) Molded SOJ, Pb-free	Low Power	Commercial
	CY7C199CNL-15ZXC	51-85071	28 TSOP I (8 x 13.4 mm), Pb-free	Low Power	Commercial
	CY7C199CNL-15VXI	51-85031	28-Lead (300-Mil) Molded SOJ, Pb-free	Low Power	Industrial
20	CY7C199CN-20VC	51-85031	28-Lead (300-Mil) Molded SOJ	Standard	Commercial
	CY7C199CN-20ZI	51-85071	28 TSOP I (8 x 13.4 mm)	Standard	Industrial
	CY7C199CN-20ZXI	51-85071	28 TSOP I (8 x 13.4 mm), Pb-free	Standard	Industrial
25	CY7C199CN-25PC	51-85014	28 DIP (6.9 x 35.6 x 3.5 mm)	Standard	Commercial
	CY7C199CN-25PXC	51-85014	28 DIP (6.9 x 35.6 x 3.5 mm), Pb-free	Standard	Commercial

**Package Diagrams**

**Figure 1. 28-pin TSOP I (8 x 13.4 mm), 51-85071**

NOTE: ORIENTATION I.D. MAY BE LOCATED EITHER AS SHOWN IN OPTION 1 OR OPTION 2

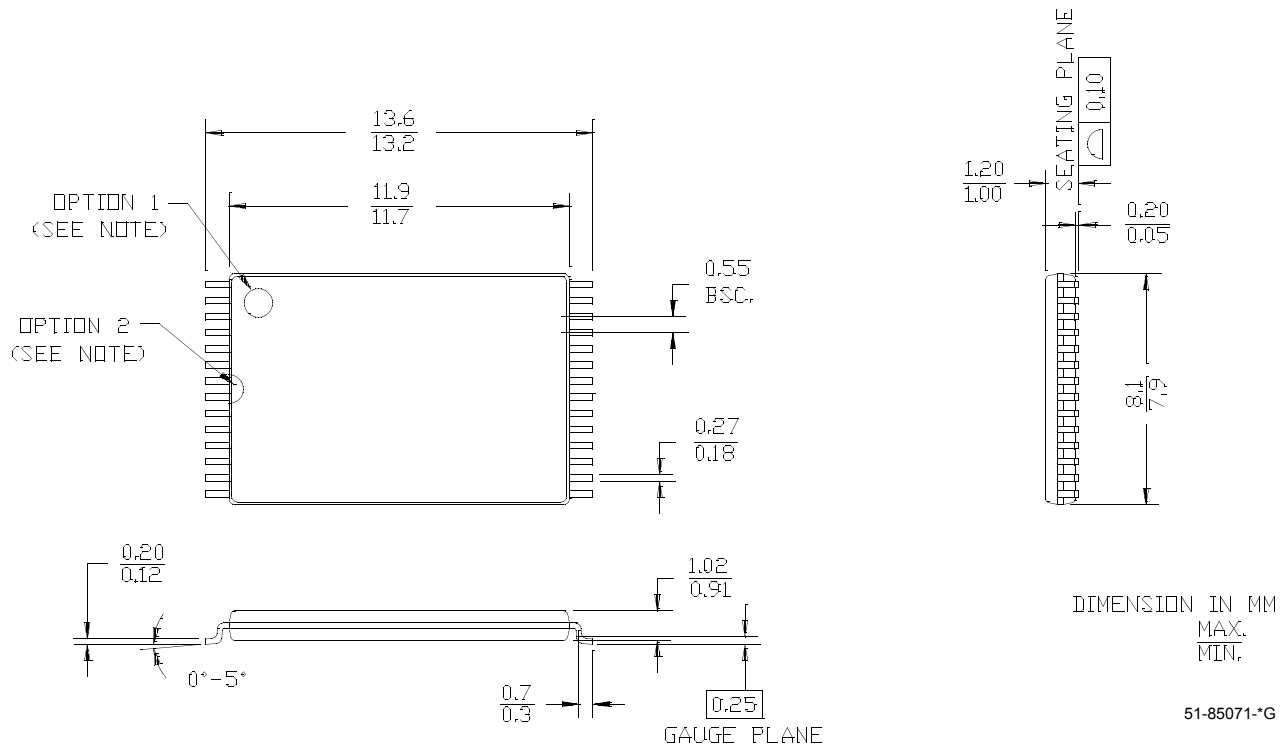

**Package Diagrams** (continued)

**Figure 2. 28-pin (300 Mil) Molded SOJ, 51-85031**

NOTE :

- 1. JEDEC STD REF MO088
  - 2. BODY LENGTH DIMENSION DOES NOT INCLUDE MOLD PROTRUSION/END FLASH  
MOLD PROTRUSION/END FLASH SHALL NOT EXCEED 0.006 in (0.152 mm) PER SIDE
  - 3. DIMENSIONS IN INCHES
- MIN.  
MAX.

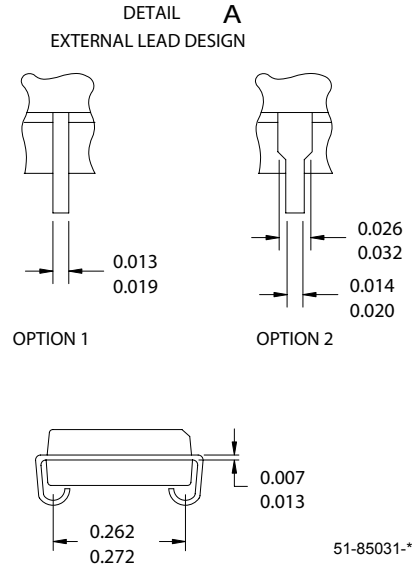
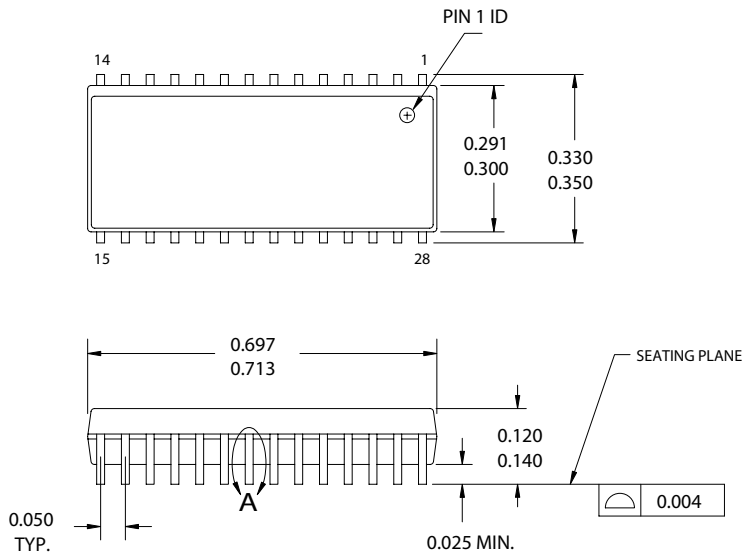

Package Diagrams (continued)

Figure 3. 28-pin (300 Mil) PDIP, 51-85014

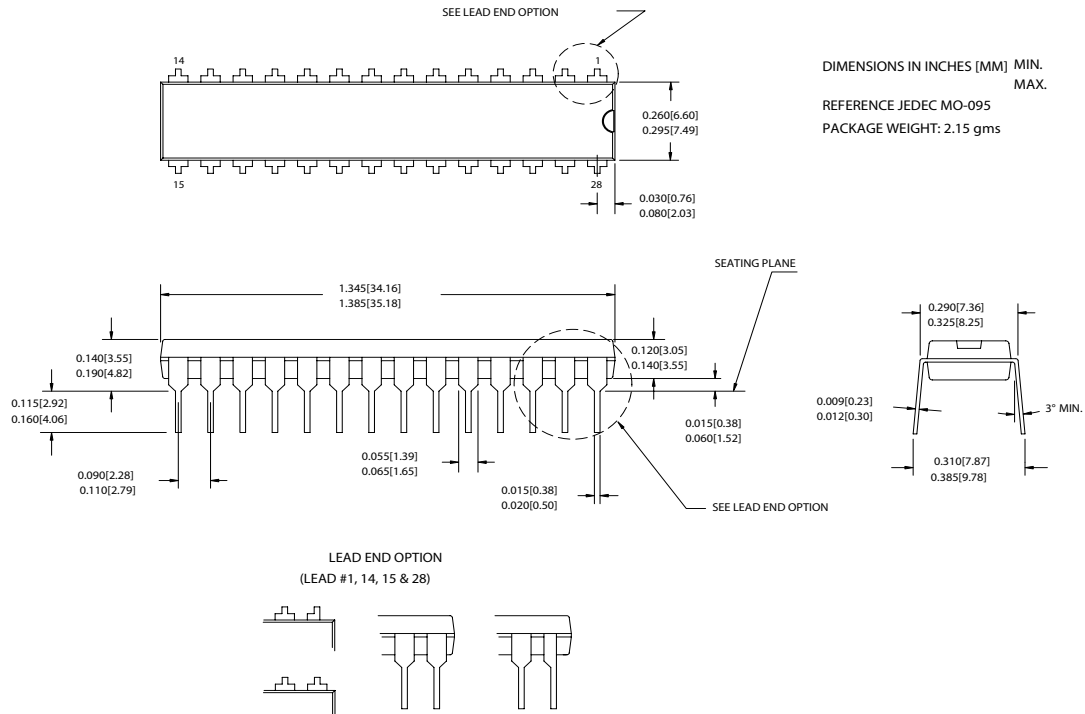

51-85014-\*D

All product and company names mentioned in this document may be the trademarks of their respective holders.

**Document History Page**

Document Title: CY7C199CN, 256K (32K x 8) Static RAM Document Number: 001-06435				
REV.	ECN No.	Issue Date	Orig. of Change	Description of Change
**	430363	See ECN	NXR	New Data Sheet
*A	684342	See ECN	VKN	Added Automotive-A Information Updated Ordering Information Table
*B	839904	See ECN	VKN	Added $t_{DOE}$ spec for Automotive-A part in AC Electrical characteristics table